

WTO

nanoFlex[®]

The new quick change system.
Compact design and high precision.

Minimal investment, maximum expandability.



Designed
for
Swiss Type
Lathes

nanoFlex®

The perfect combination: ER collet chuck and modular quick change system in one toolholder.

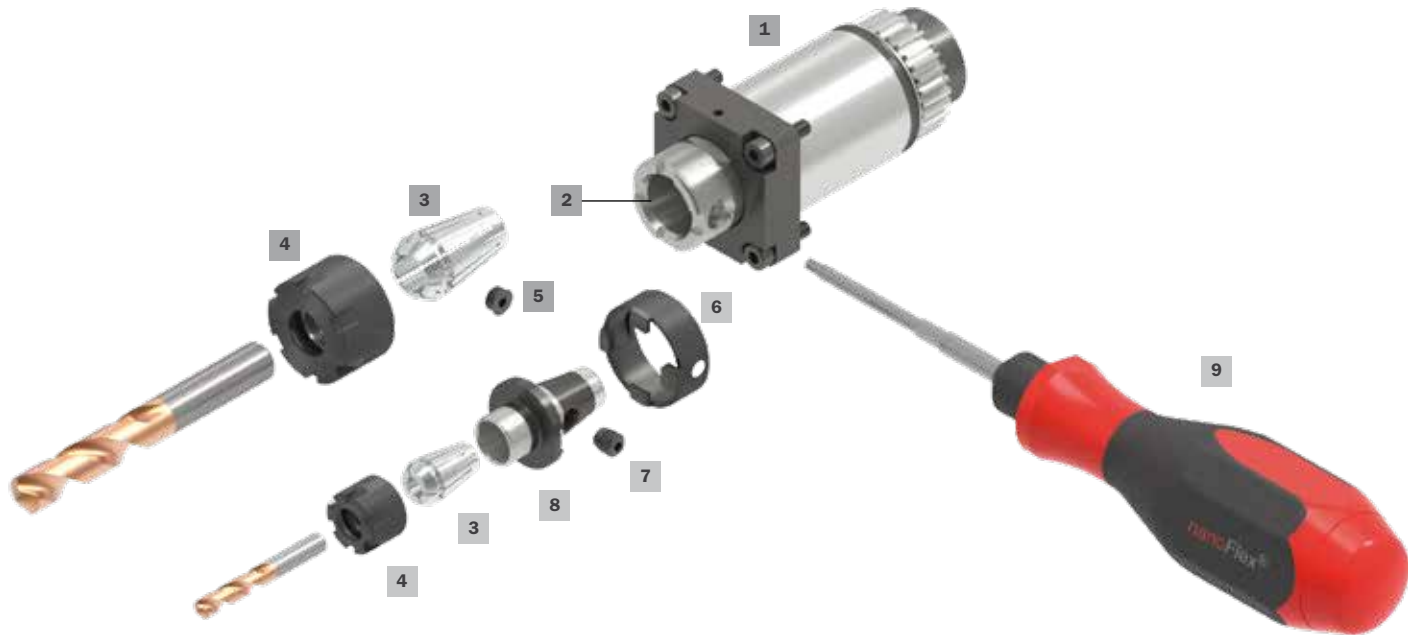

nanoFlex® chuck prepared for adapter clamping.

- 1** - Toolholder
- 2** - nanoFlex® chuck
- 3** - ER collet
- 4** - Collet nut
- 5** - Plug screw for spindle side
- 6** - Drive ring for torque transmission of the nanoFlex® quick change adapter
- 7** - nanoFlex® clamping screw
- 8** - nanoFlex® quick change adapter
- 9** - One-hand wrench with set torque value to clamp and unclamp the nanoFlex® quick change adapters
- 10** - Drive dogs for torque transmission
- 11** - Taper for ER collets and nanoFlex® adapter



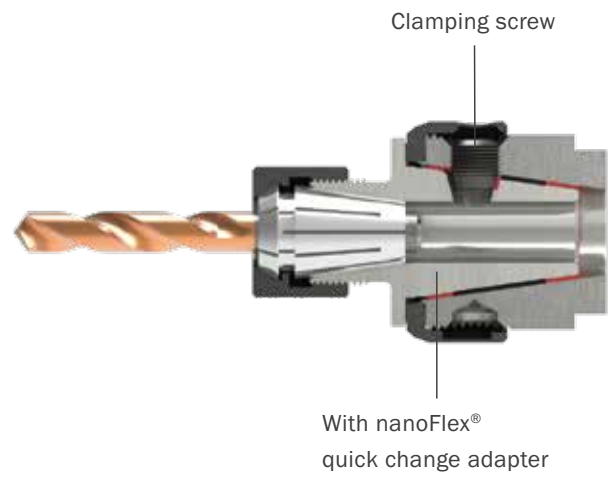
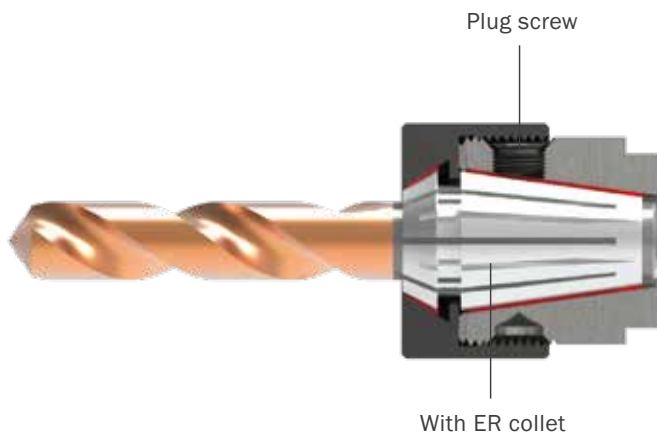

Regular tool clamping using collets.

Tool clamping using quick change adapters.



Handling using quick change adapters

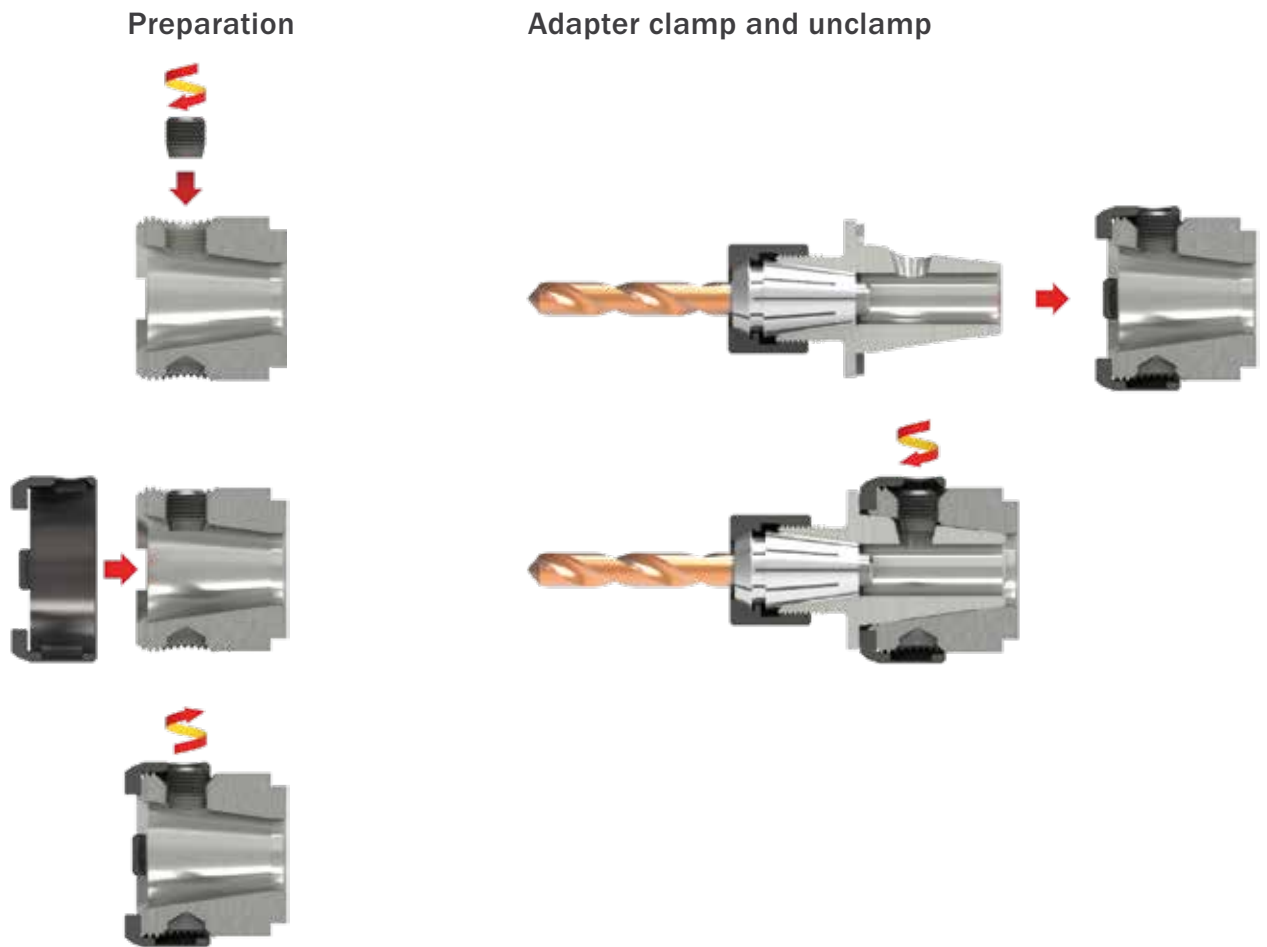

Handling using collets

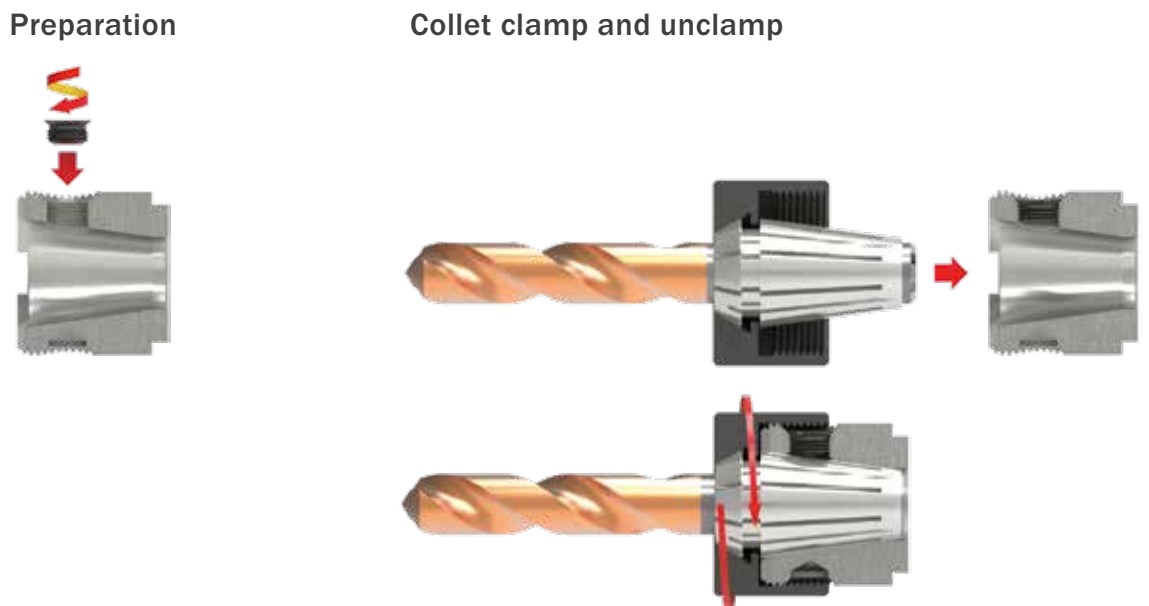

Cylindrical shank holder

with cylindrical shank and flat.

For flexible use of ER collets and nanoFlex® adapters in boring bar and sleeve holders.

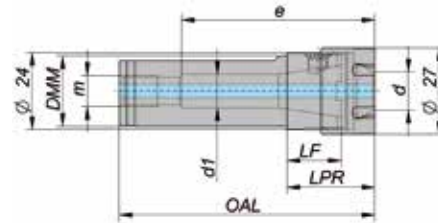



Size	Item No.	DMM	d min.	d max.	LF	LPR	OAL	d ₁	m	e			
ER-16NF	NF16-SSH-075-A	¾"	0.5	10	17	28.5	78.5	10.5	G1/8"	60.5	NF16-SCN-A	107520005	NF16-SPLA
ER-16NF	NF16-SSH-022-A	22	0.5	10	17	28.5	80	10.5	G1/8"	60.5	NF16-SCN-A	107520005	NF16-SPLA
ER-16NF	NF16-SSH-025-A	25	0.5	10	17	28.5	78.5	10.5	G1/8"	60.5	NF16-SCN-A	107520005	NF16-SPLA

Dimensions in mm. Including clamping nut and plug screw ER-16NF.

Collet chuck adapter

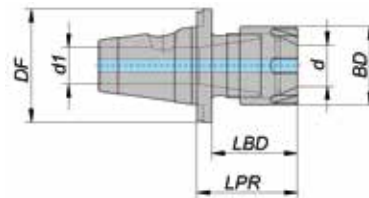
DIN 6499, ISO 15488





Size	Item No.	DF	d min.	d max.	d ₁	BD	LPR	LBD	Collet size		
ER-16NF	NF16-SAD-ER08-A	23	0.5	5	5.5	12	20.5	17.5	ER 8	200508000	107508005
ER-16NF	NF16-SAD-ER11-A	23	0.5	7	7.5	16	20.5	17.5	ER 11	200511000	107511005

Dimensions in mm

Weldon/Whistle Notch adapter

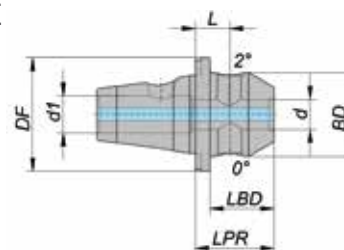
for tool shanks according to DIN 6535-HB and -HE



Size	Item No.	DF	d	BD	LPR	LBD	L	d ₁		
ER-16NF	NF16-SAD-WW06-A	23	6	17	16	13	7	7.5	12882	26071

Dimensions in mm

Master gauge/Preset master adapter

etched with actual gauge length measurement

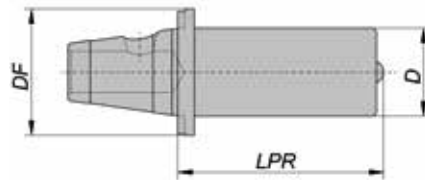





Size	Item No.	DF	D	LPR
ER-16NF	NF16-SMA-A	23	16	37.5

Dimensions in mm

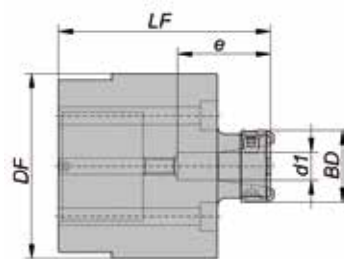
Mounting and presetting device nanoFlex®

for cutting tool change and presetting of nanoFlex® adapters



Size	Item No.	DF	BD	LF	d ₁	e				
ER-16NF	NF16-SMD-A	70	27	80	10.5	35	NF16-STW-A	NF16-SDR-A	NF16-SCS-A	29205



Dimensions in mm

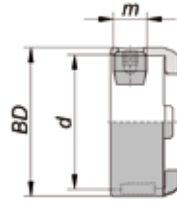

Drive ring

for use with nanoFlex® adapters



Size	Item No.	BD	d	m			
ER-16NF	NF16-SDR-A	27	24	M6x0.5	10IP	NF16-SCS-A	NF16-STW-A



Dimensions in mm. Clamping screw included

Torque screwdriver

to clamp nanoFlex® adapters with one hand



Note:
Blade replaceable



Size	Item No.		Nm	
ER-16NF	NF16-STW-A	10IP	2.5	109330

Dimensions in mm

Clamping screw ERNF

to clamp nanoFlex® adapters



Size	Item No.		Nm	
ER-16NF	NF16-SCS-A	10IP	2.5	NF16-STW-A

Dimensions in mm

Collet nut ERNF

suitable for nanoFlex® spindle collet chuck
DIN 6499, ISO 15488

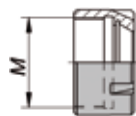



Size	Item No.	M	Nm	
ER-16NF	NF16-SCN-A	M24x1	45	107520005

Dimensions in mm

Plug screw ERNF

to plug the clamping screw hole



Size	Item No.		Nm	
ER-16NF	NF16-SPL-A	10IP	2.5	NF16-STW-A

Dimensions in mm

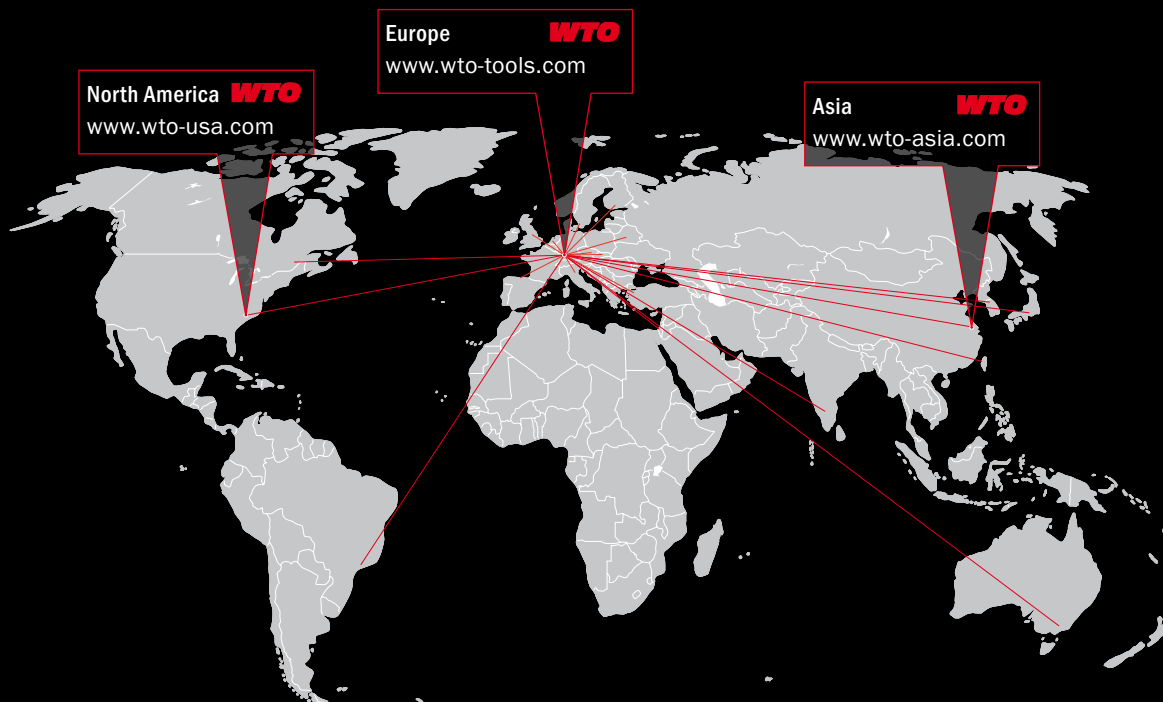

WTO Werkzeug-
Einrichtungen GmbH
Neuer Hohdammweg 1
77797 Ohlsbach
Germany

WTO Inc.
13900-F South Lakes Dr.
Charlotte, NC 28273
USA

WTO Asia
WTO Precision Tool Holders
(Shanghai) Co. Ltd.
Room 109-110, Building 2
No. 228 Banting Road
Jiuting Town,
Songjiang District
201615 Shanghai
China

Our distribution partners. Competence right there.

Australia
Dimac Tooling Ltd.
sales@dimac.com.au

France, east
Christophe Archambault
alm@wto.de

Japan
NK Works Co. Ltd.
k_samba@nk-works.co.jp

Slovakia
ALBA precision s.r.o.
albabprecision@albabprecision.sk

Brazil
TF2
tfdois@tfdois.com.br

France, west
Christophe Archambault
car@wto.de

Korea
WTO Office Korea
is.chon@wto-korea.com

Spain
ITALMATIC, S.A.
italmatic@italmatic.es

Canada
Mittmann Industrial Inc.
info@mittmann.com

Great Britain
Cutwel Ltd.
sales@cutwel.net

Mexico
Workholding Engineering De México
info@wem.com.mx

Sweden
Bonhron & Ewing AB
info@bonhron-ewing.se

China
Shanghai Gangde
wtocando@yahoo.com

Hungary
Prevotex Hungary Kft.
info@prevotex.hu

Netherlands
Toologic BeNeLux B.V.
info@toologic-benelux.nl

Switzerland
Utilis AG
info@utilis.com

Czech Republic
ALBA precision, spol. s.r.o.
info@albabprecision.cz

India
Ulhas Patil
u.patil@wto-asia.com

Norway
Helge Karlsen Verktøy og Maskin AS
hkvm@hkvm.no

Taiwan
Kaiko Co., Ltd.
info@kaiko.com.tw

Denmark
AVN Teknik A/S
cjo@avn.dk

Israel
E.Y.A.R. Ltd.
boris@eyar.co.il

Poland
ARCO Andrzej Rudenko
info@arcotools.pl

Turkey
MYK CNC MAKINA SAN. VE
huseyin.tatlidil@mykcnc.com.tr

Finland
Suomen Terätuonti Oy
myynti@stt.as

Italy
Prymark srl
commerciale@prymark.it

Romania
SC Elif Trading SRL
bulent.ozkan@eliftrading.com

Ukraine
„LLC“ SPA Stankopromimport
info@phoenix-ua.com